

General Specifications:

- 2x6 Digit display, double PRESET, double OUT, up/down counter
- Counts switch, proximity switch & incremental encoder input
- Password protection
- Selectable input frequency
- Calibration constant; 0.00001.....9.99999
- Selectable decimal point; 1. 3. Digit
- 7 input / 10 output function options
- Adss "OFFSET" to Count Value
- PRESET1; Absolute / Relative option
- OUT; latch or 0.1.....999.9 seconds pulse
- Loads count value & OUT status at the lastest power failure after the first power on
- RESET via front panel
- Displays Preset 1/2 values
- EEPROM memory to store settings

Technical Specifications:

- Panel Hole Sizes : 67x67mm
- Display : 2x6 Digit 7 Segment display
- Count Input : 2 x (Max: 7500 Hz, 5-30V)
- NPN Selection : Connect "nnp select" to "+12V" to select NPN sensor for Cp1 and Cp2. Reset input is always PNP. For totem pole or PNP type sensor "nnp select" left unconnected.
- Sensor Types : PNP/NPN proximity switch - NPN/PNP/Totem-pole output encoder
- Input Frequency : 20, 50, 2500, 7500 Hz selectable.
- Reset Input : 10ms (min) , Positive input (PNP only) (5.....30V)
- Output : Out1, Out2; 2x Relay (O-NO-NC), 250VAC, 2A, Rezistif Yük
2x Open Collector (NPN), 30V, 100mA max.
- Sensor Supply : 12VDC, 50mA(max.) unregulated
- Supply Voltage : 100...240VAC, 50-60Hz
- Power Consump. : < 8VA
- Operating Temp. : -20 °C.....55 °C
- Operating Altitude : < 2000m

Warning:

- Use shielded and twisted signal cables and connect shield to ground. Keep all signal cables away from circuit breakers, inductive loads, device/cables emitting electrical noise and power cables.
- Take precautions against environmental conditions like humidity, vibration, pollution and high/low temperature during installation.
- Use fuse (F250mA 250VAC) on mains/supply input of the device. Use appropriate cables for supply connections. Apply safety regulations during installation.
- Prefer to use (Input = Phase1) option for encoders, select (In.Freq = 20) to count mechanical switch ON-OFF pulses, select the minimum input frequency option that suits your application.

- For Input = 1up2up, 1up2dn, Phase2; input signal frequency shall be at most 1/2 of the selected input frequency option if both inputs are used. And for Input = Phase4; input signal frequency shall be at most 1/4 of the selected input frequency option if both inputs are used.

Connection

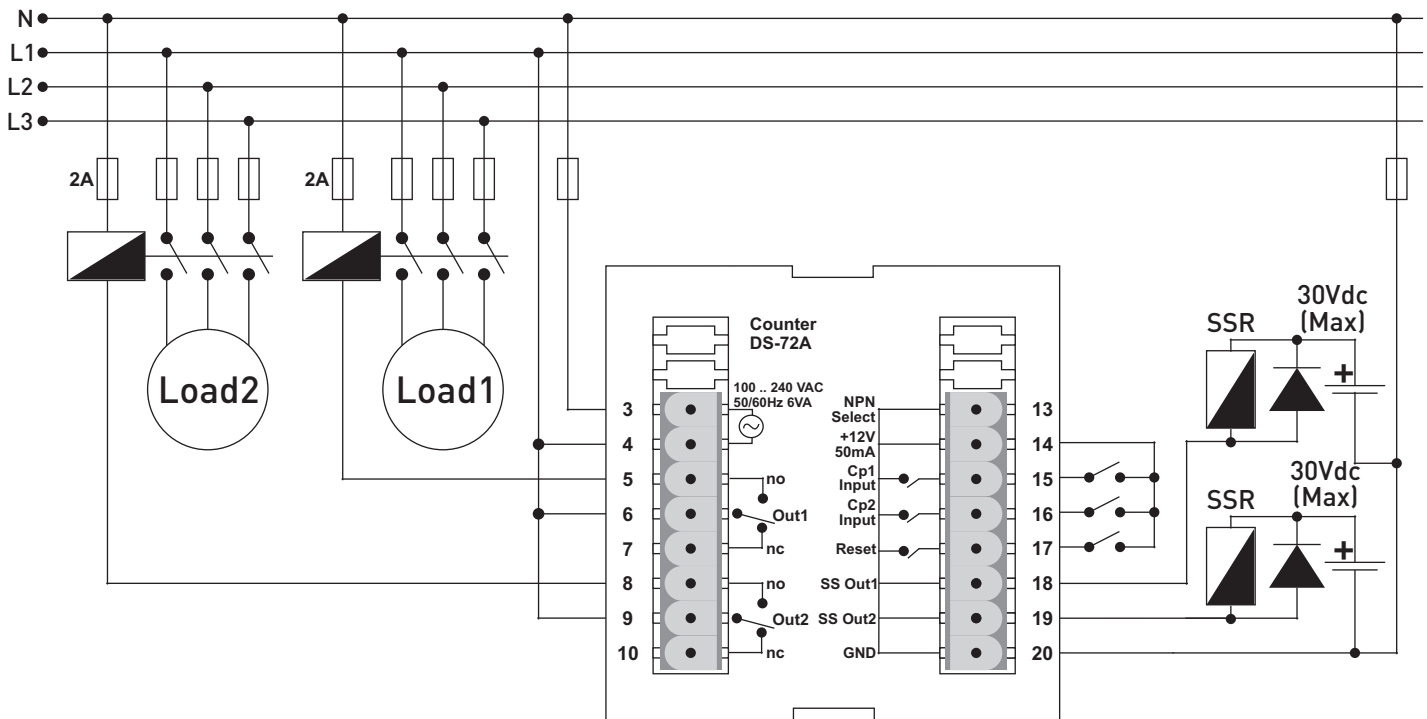

Notes:

- Connect SS Out return pin directly to GND.
- Use free-wheeling diode to protect SS Out.
- To select PNP option; connect "npn select" to "+12V".

Dimensions

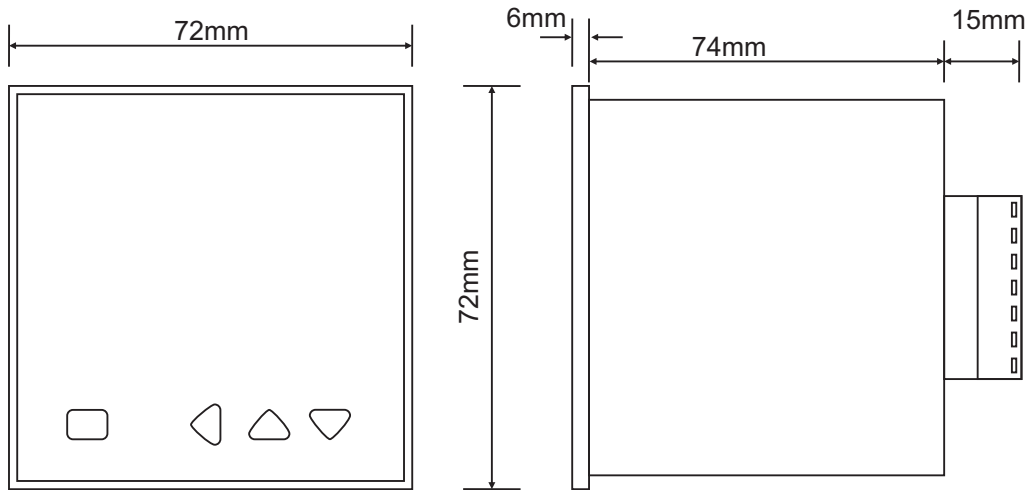

Programming Steps

Reading Preset1 / Preset2 value at lower display:

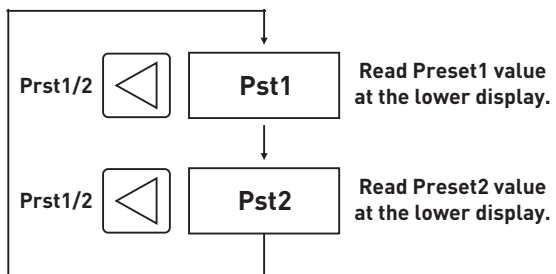

Front Panel RESET:

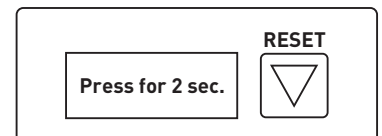

Programming Preset1 and Preset2 Absolute Values:

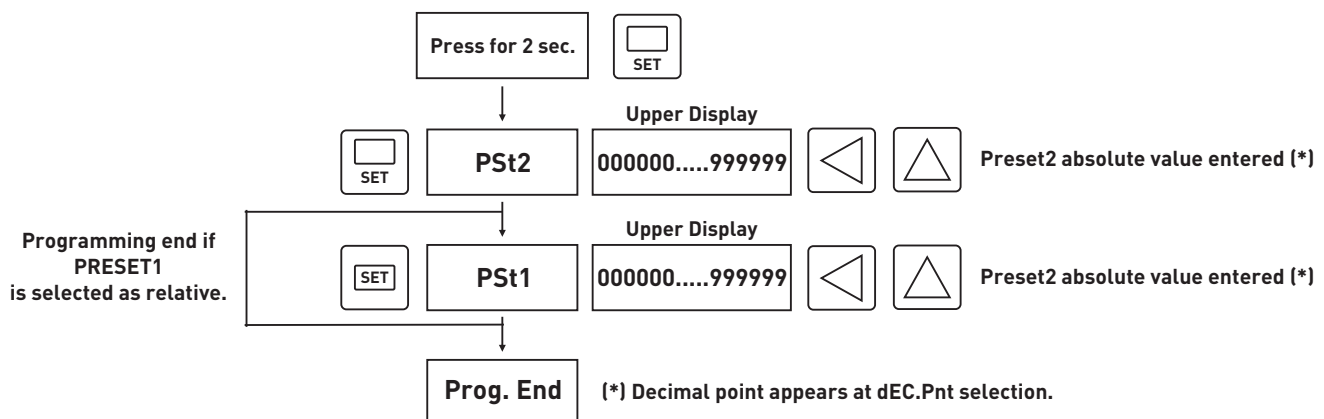

Input Types

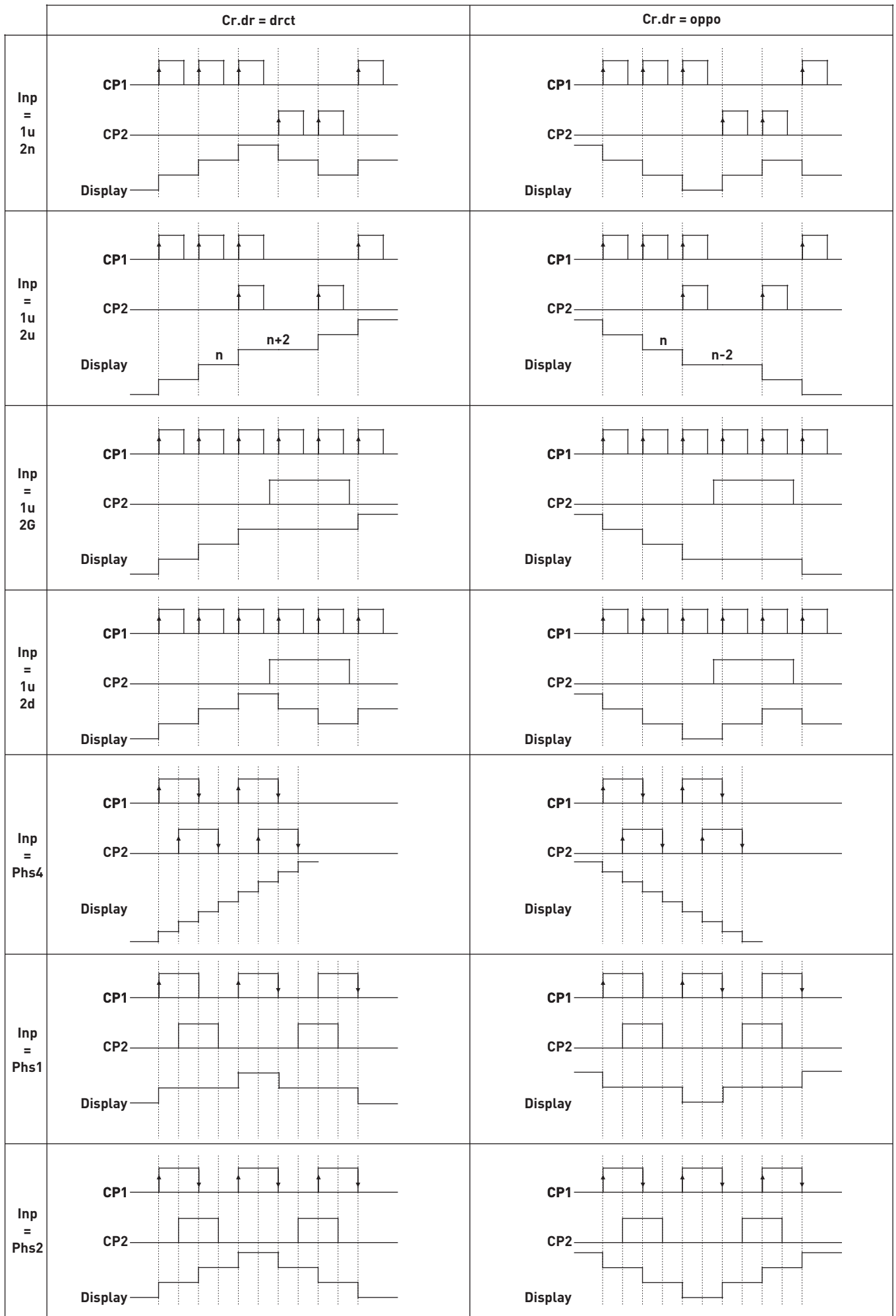

PNP / Totem Pole ON
 PNP / Totem Pole OFF

NPN OFF
 NPN ON

Programming Parameters:

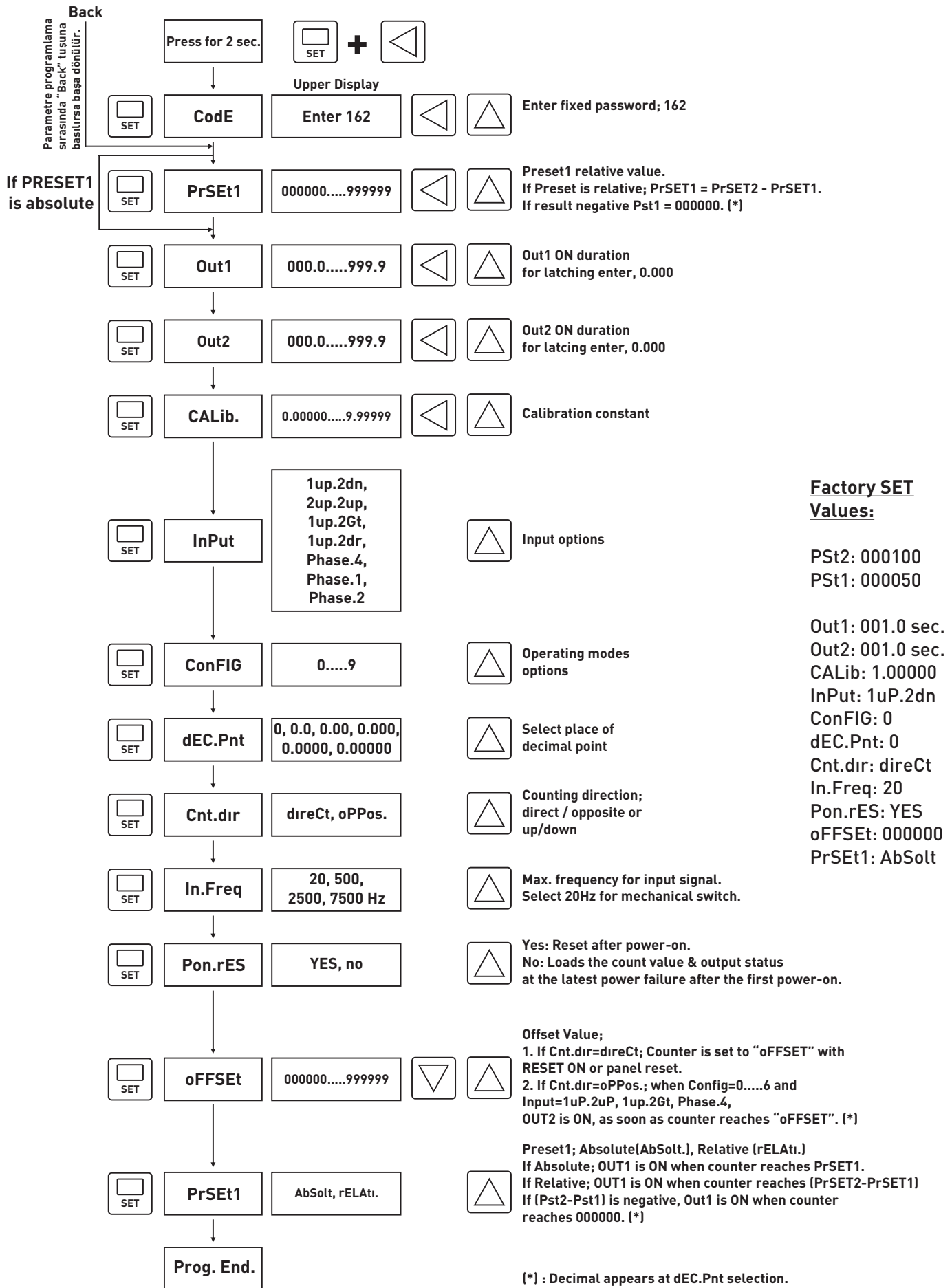

Note: If no entry is done for 20 sec. during programming, current entries are accepted and saved to EEPROM memory.

Operating Modes

	Inpt = 1up2up, 1up2Gt, Phase4 Cnt.Dir = direct	Inpt = 1up2up, 1up2Gt, Phqse4 Cnt.Dir = opposite	Inpt = 1up2dn, 1up2dr, Phase1, Phase2	Comment
Conf 0				Counting continues up/down until RESET ON after, Preset1 or Preset2 is reached. OUT1 pulse is independent of OUT2.
Conf 1				Counting stops until RESET ON after Preset1 or Preset2 is reached. OUT1 pulse is independent of OUT2.
Conf 2				Counting continues up/down until RESET ON after, Preset1 or Preset2 is reached. OUT1 is OFF with OUT2 pulse OFF. OUT1 pulse is independent of OUT2.
Conf 3				Counter is reset after Preset2 is reached. OUT1 is OFF with OUT2 pulse OFF, OUT1 pulse is independent of OUT2.
Conf 4				Counting continues up/down after Preset2 is reached. Counter is reset and OUT1 is OFF with OUT2 pulse OFF, OUT1 pulse is independent of OUT2.
Conf 5				Counting stops after Preset2 is reached. Counter is reset and OUT1 is OFF with OUT2 pulse OFF. OUT1 pulse is independent of OUT2.
Conf 6				Counter is reset after Preset2 is reached but display freezes until the end of OUT2 pulse. OUT1 is OFF with OUT2 pulse OFF. OUT1 pulse is independent of OUT2.
Conf 7				OUT1 is ON when counter is equal to Preset1 else OFF. OUT2 is ON when counter is equal to Preset2 else OFF. Use SS Outs if ON duration is too small for relay ON time.
Conf 8				OUT1 is ON when counter is less than equal to Preset1 else OFF. OUT2 is ON when counter is greater or equal to Preset2 else OFF.
Conf 9				OUT1 is ON when counter is greater than equal to Preset1 else OFF. OUT2 is ON when counter is greater or equal to Preset2 else OFF.

■ Pulse

□ Latched Output